

# IT7900EP High Performance Regenerative Grid Simulator

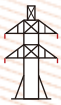

E-mobility



Grid



Energy  
Storage



Photovoltaic



IEC Testing



*Your Power Testing Solution*

# IT7900EP High Performance Regenerative Grid Simulator



The IT7900EP series high-performance regenerative grid simulator provides an advanced all-in-one test solution. Built on SiC technology, it can operate not only as a high-power AC source, but also as a grid simulator, a four-quadrant power amplifier, and a regenerative AC/DC electronic load. With built-in programmable RLC function, it is suitable for testing requirements related to IEEE 1547 and UL 1741. Full four-quadrant operation and efficient regenerative capability allow power to be fed back cleanly to the grid, meeting environmental requirements while significantly reducing electricity consumption and heat dissipation costs. Its compact, modular, and efficient design enables the IT7900EP to deliver up to 21 kVA in a 3U unit, with total power expandable to over 1 MVA through master-slave paralleling. The intuitive color touchscreen interface allows users to define different waveforms directly. Rich operating modes support single-phase, three-phase, and reverse-phase testing, providing high flexibility for applications in PV, ESS, EV, and more.



## ESS

PCS energy storage converters, microgrids, home PV energy storage devices



## Power Electronics

Uninterruptible Power Supply System (UPS), AC power supply, inverter Generators, transformers, AC fans



## PV

PV inverter, grid power system



## Electronic Components

Circuit breakers, fuses, connectors



## EV

V2G, V2X, EVSE, vehicle type converters, electric vehicle power supply



## Scientific research, universities, laboratories, certification bodies

AC-DC power adapter testing, electromagnetic compatibility testing

| Model              | Output voltage Vac |       | Output current Aac |          | Output power Pac | Phase                | Height |
|--------------------|--------------------|-------|--------------------|----------|------------------|----------------------|--------|
|                    | V L-N              | V L-L | Arms(1Φ)           | Arms(3Φ) |                  |                      |        |
| IT7921EP-350-105   | 350V               | 606V  | 105A               | 35A      | 21kVA            | 1Φ,3Φ,reversed phase | 3U     |
| IT7942EP-350-210   | 350V               | 606V  | 210A               | 70A      | 42kVA            | 1Φ,3Φ,reversed phase | 6U     |
| IT7963EP-350-315   | 350V               | 606V  | 315A               | 105A     | 63kVA            | 1Φ,3Φ,reversed phase | 15U    |
| IT7984EP-350-420   | 350V               | 606V  | 420A               | 140A     | 84kVA            | 1Φ,3Φ,reversed phase | 27U    |
| IT79105EP-350-525  | 350V               | 606V  | 525A               | 175A     | 105kVA           | 1Φ,3Φ,reversed phase | 27U    |
| IT79126EP-350-630  | 350V               | 606V  | 630A               | 210A     | 126kVA           | 1Φ,3Φ,reversed phase | 27U    |
| IT79147EP-350-735  | 350V               | 606V  | 735A               | 245A     | 147kVA           | 1Φ,3Φ,reversed phase | 27U    |
| IT79168EP-350-840  | 350V               | 606V  | 840A               | 280A     | 168kVA           | 1Φ,3Φ,reversed phase | 37U    |
| IT79189EP-350-945  | 350V               | 606V  | 945A               | 315A     | 189kVA           | 1Φ,3Φ,reversed phase | 37U    |
| IT79210EP-350-1050 | 350V               | 606V  | 1050A              | 350A     | 210kVA           | 1Φ,3Φ,reversed phase | 37U    |
| IT79231EP-350-1155 | 350V               | 606V  | 1155A              | 385A     | 231kVA           | 1Φ,3Φ,reversed phase | 37U    |

\*Please contact ITECH for higher power needs.

\*The above specifications are subject to update without notice.

## Parameter Features

- Adopt advanced SiC technology
- High power density, up to 21 kVA for 3U
- Voltage can reach 350V L-N
- Highly efficient power regeneration
- Master and slave equal flow, parallel machines up to 1MVA
- Comprehensive working modes selectable: single-phase, three-phase, reversed phase(split phase) , Voltage extension to 200% of rated voltage in reversed mode
- Support LIST/SWEEP/Surge&Sag three waveform modes
- Built-in rich waveform database
- Harmonic simulation and analysis function up to 50 times,built-in IEC61000-3-2/3-12\*1
- Can simulate arbitrary waveform output, support CSV file import waveform
- Phase angle 0-360° settable
- Touch screen design, simple UI interface
- Built-in USB/CAN/LAN /Digital IO interface,optional GPIB/analog & RS232 interface
- Full protection functions including automatic clearing,POVP ,watchdog, etc.
- Support CANopen\*2、 Modbus、 LXI、 SCPI communication

## Source Features

- Regenerative grid simulator & full 4-Quadrant AC&DC power sources
- Frequency: 16~2400Hz
- Power Amplifier function for PHIL applications
- Four output modes of AC/DC/AC+DC/DC+AC can be realized
- Programmable output impedance,simulation of real-world impedance
- Harmonic/inter harmonic synthesis
- Compliance tests incl. LVRT /Phase Jump/Frequency variation/ harmonic injection
- Supported regulatory testing include IEC61000-4-11/4-13/4-14/4-17/4-28/4-29

## Load Features

- Regenerative full 4-Quadrant AC&DC load
- Frequency: 16-500 Hz
- AC mode supports CC/CP/CR/CS/CC+CR/CE multiple operating modes, and CE mode can simulate a variety of circuit topologies such as single-phase rectifier RLC and shunt RLC.
- DC mode supports 9 working modes such as CC/CR/CP/CV
- AC mode supports both rectified and non-rectified modes
- Adjustable crest factor: 1.414 ~ 5.0
- Support phase shift function in the range of -180°~180° \*4
- The unit power factor1 function allows the current waveform to vary with the voltage waveform and the power factor is as close to 1 as possible
- Supporting unloading angle control, 0-359° adjustable

\*1.Voltage/current harmonic analysis, voltage harmonic simulation in source mode, current harmonic simulation in load mode, fundamental wave≤60Hz

\*2.Stay tuned

\*3 After turning on the rectification function, the setting range of the phase shift is restricted by the crest factor



01

## All in one unit

IT7900EP series integrates 3 products, a grid simulator, an AC/DC programmable power supply and a regenerative AC/DC load.

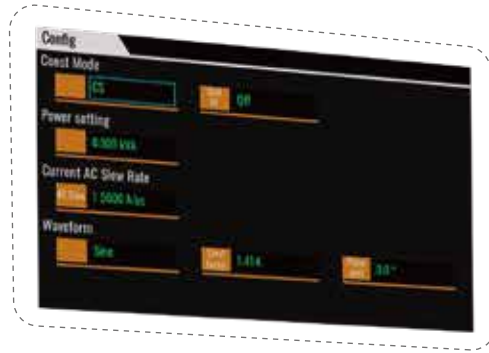

02

## High power regeneration efficiency

Whether it is used as a grid simulator or a load, in AC or DC mode, the IT7900EP is high efficiently power regenerative. The energy generated by the DUT can be fed back to the local grid instead of dissipating in the form of heat, which is good for energy-saving and environment protection.

03

## High power density

The IT7900EP series can provide 21kVA power output under 3U, and the voltage output can also reach 350V, the size is only 1/12 of the ordinary AC power supply on the market, which can be placed on your test bench, largely saves the space.



## 04

**Various test items**

Sliding the touch screen of the IT7900EP series is as simple as operating a mobile phone. The intuitive GUI not only allows multiple parameters displayed at the same time, but also multiple display ways are selectable, such as waveform graph, histogram, vector diagram and list.

## 05

**Multiple protection and communication interfaces**

IT7900EP series has a variety of protection functions to ensure the safety of the test, including: over-current Rms protection, over current peak protection, over temperature protection, automatic clear protection, software watchdog and so on. IT7900EP not only has built-in USB/CAN/LAN/digital IO interfaces, but also provides optional GPIB/analog & RS232.

## 06

**Power extension by master-slave parallel connection**

Through the master-slave parallel connection, the power of IT7900P can be extended up to 1MVA. It can be easily paralleled without disassembling and assembling the cabinet, and the multi-modules can synchronously share the current output. Not only will it retain all functions after paralleling, but there will be no precision sacrifice.

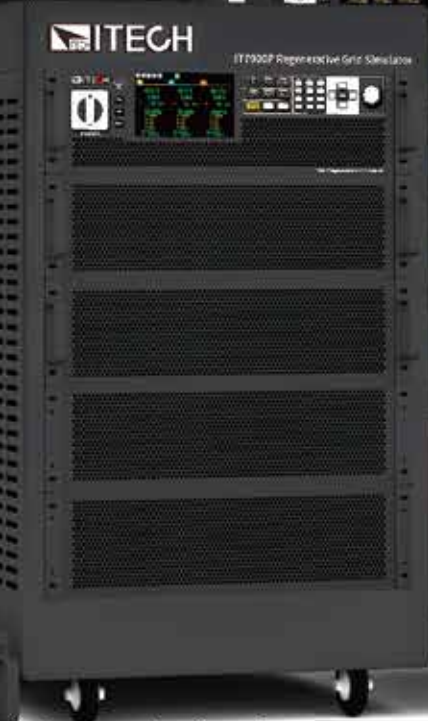

## Outstanding Features

### 4-Quadrant output

IT7900EP series is not only a full four-quadrant power grid simulator, but also a full four-quadrant AC/DC electronic load. It can operate in all four quadrants. The efficient energy regeneration function makes it good for testing the frequency change of grid-connected PV inverters, voltage transients and anti-islanding protection.

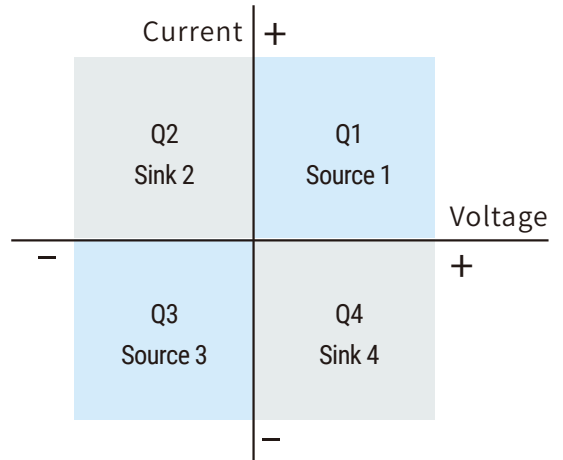

### Full 4-Quadrant Power Amplifier

The IT7900P series regenerative grid simulator can be used as a power amplifier to complete power hardware in the loop (PHIL) applications for microgrids, energy storage and new energy vehicles. The digital I/O or a standard suite of analog signal can be input via an external analog interface (optional) and then amplified without distortion to a real power waveshape with an external analog response time of less than 100us.

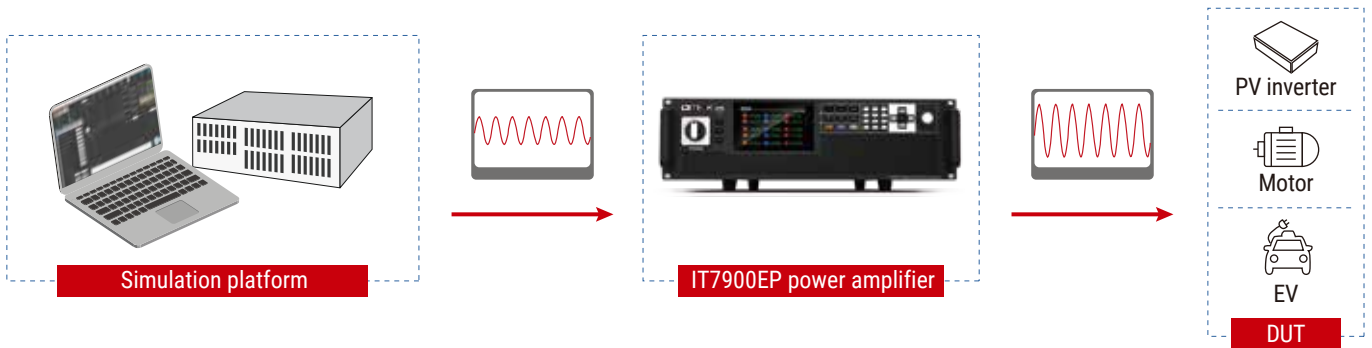

### Pre-compliance regulation test

According to industry standards, IT7900P series has built-in regulation standards such as IEC61000-4-11/4-13/4-14/4-17/4-28/4-29, IEC61000-3-2/3-12. These regulations can be recalled directly. You can also customize the test items required by regulations too.

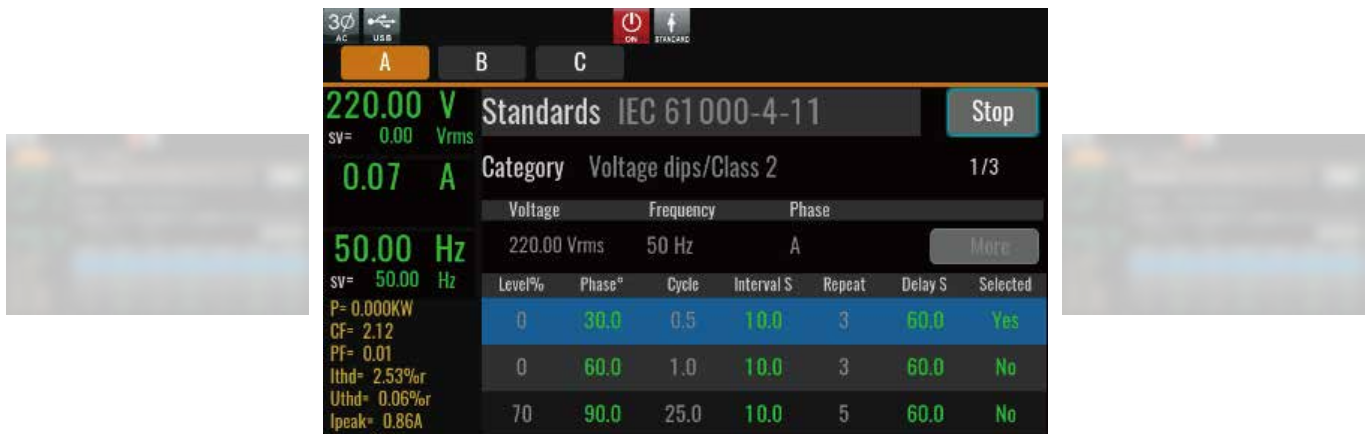

## IT7900EP High Performance Regenerative Grid Simulator

### AC/DC load conditions emulation

#### DC load mode

Constant Voltage (CV)

Constant Current (CC)

Constant Resistance (CR)

Constant Power (CP)

CC+CV

CR+CV

CP+CV

CC+CR

CP+CV+CR+CC

#### AC load mode

Constant Current (CC)

Constant Resistance (CR)

Constant Power (CP)

Constant apparent power (CS)

CC+CR

CE RLC

Single rectified RLC  
Parallel RLC

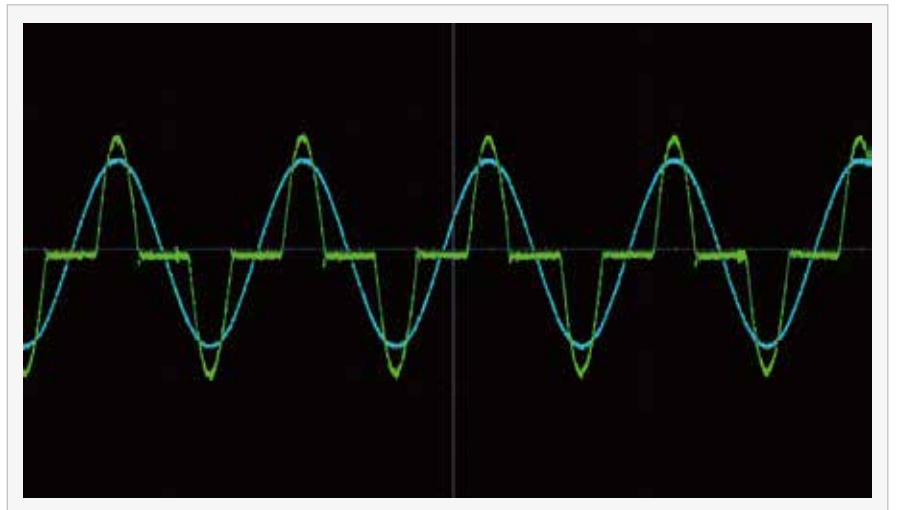
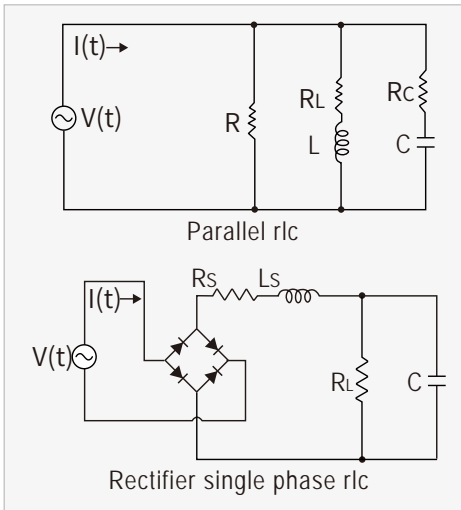

IT7900EP AC electronic load can enable the 'Rectified' function in AC mode, so that the load works in the first and third quadrants to ensure that the voltage and current flow always in the same direction. At this time, full wave, positive half wave, or negative half wave can be freely selected.

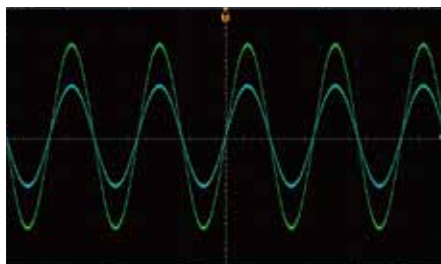

full wave rectification

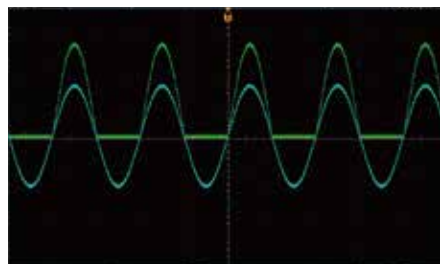

Positive half wave rectification

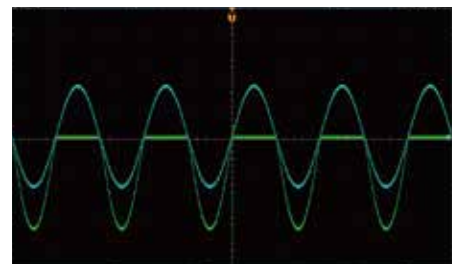

Negative half-wave rectification

## CF 1.414-5.0

The crest factor indicates the extreme peaks of the waveform. For applications that require a pure sine wave, it is desirable to have a CF value of the load current waveform of 1.414 or as close as possible. However, in practical applications, the peak shape of the current waveform of the load may become very sharp and its CF is often higher than 1.414. At this time, the starting point of the sine wave starts to shift from 0 degrees to the positive degree. So you need to correct the waveform. The Crest Factor of the IT8200 can be adjusted from 1.414 to 5.0, and it also allows to set the phase shift angle from  $-90^{\circ}$ ~ $90^{\circ}$ , correct the resulting amplitude, and keep the RMS unchanged. This enables more accurate simulation of field test conditions to ensure the reliability of the unit under test (UUT).



CC mode,CF=5



CC mode,CF=1.414



Phase= $90^{\circ}$



Phase= $-90^{\circ}$

CC phase leading / lagging



## Multiple operation modes

### AC,DC,AC+DC,DC+AC four working mode

IT7900EP series can be used as a "full four-quadrant AC/DC power supply" and provides four output modes: AC, DC, AC+DC, and DC+AC. Not only provide pure AC/DC output, use AC+DC and DC+AC output modes to realize "AC output superimposed DC bias" and simulate "DC output waveform with ripple" to meet the complex application requirements of engineers. In DC mode, the rated power in 100% AC mode can be achieved.

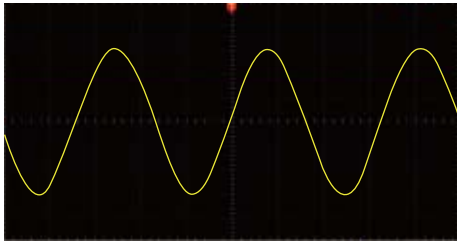

AC

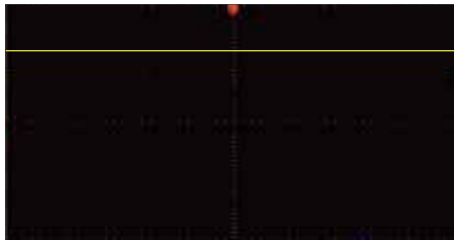

DC

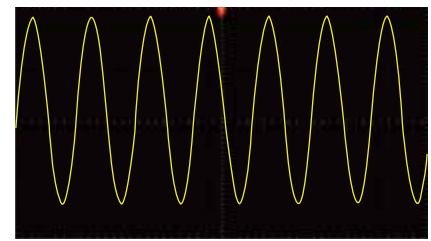
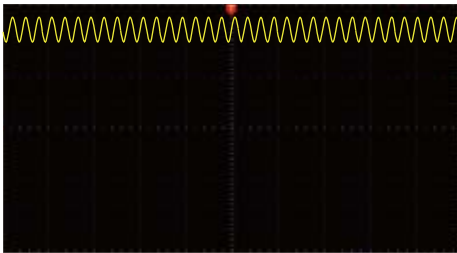
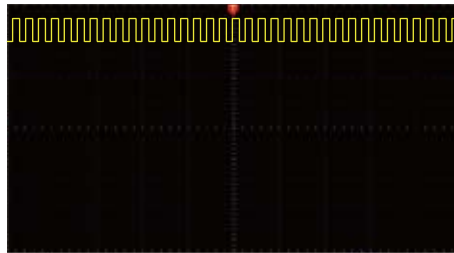
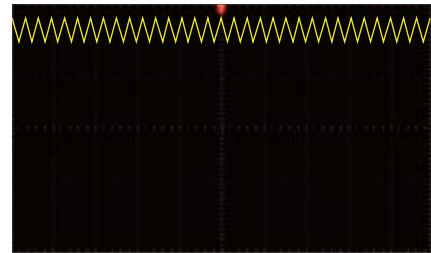
AC+DC  
Vac=45V,dc bias=10VDC+AC  
Vdc=50V, sine ripple Vac=5V,  
frequency 150HzDC+AC  
Vdc=50V, square ripple Vac=5V,  
frequency 150HzDC+AC  
Vdc=50V, triangle ripple Vac=5V,  
frequency 150Hz

## Measurement Functions

### Data record

Thanks to the function of large data recording, IT7900EP series is capable of recording up to 7 hours of continuous data at short intervals (fastest: 100ms). And it's easy to view the complete curve generating from the start to the end of the test. There are six curves that can be displayed at the same time at most. In addition, you can slide the vernier calipers on the screen to check the exact data at a particular point in the current trend curves. It is useful for analyzing errors during test for a long time or inflection points during loading, etc. Besides, you can export the test data for further analysis by front panel USB interface



### Harmonic analysis

Harmonic analysis functions include both voltage and current harmonic measurement. In the harmonic mode, the voltage and current total harmonic distortion (THD) and the phase difference test of the harmonic to the fundamental wave can be realized. In addition, you can make multiple harmonic measurements. The test results are displayed in a list, histogram or vector diagram, easy to check.

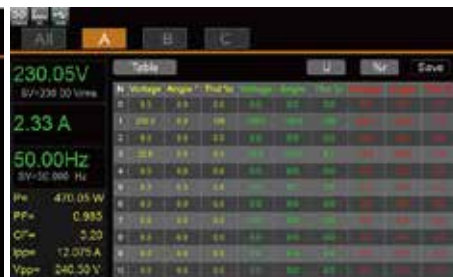

## Powerful waveform editing function

### Built-in various type of distorted waveforms

In addition to sine waveform, IT7900EP series provides various standard AC waveforms, such as triangular wave, sawtooth wave, square wave, trapezoidal wave and clipped sine wave. These waves can be easily recall from the menu and displayed in the LCD touch screen. Moreover, in combination with sequence programming function, users can realize multiple waveform continuous output, to cope with complex power line disturbance test.

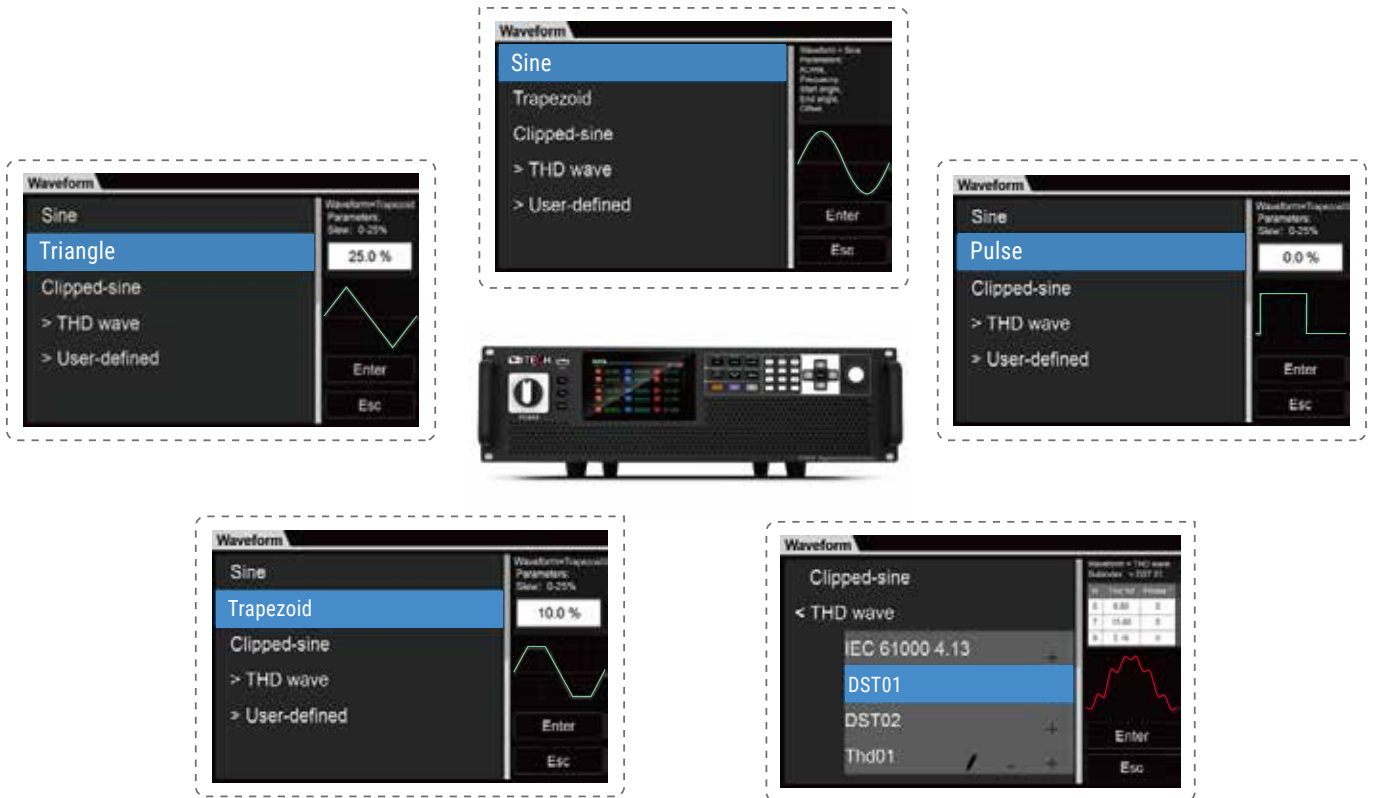

### User-defined waveform function

IT7900EP series provides user-defined waveform editing function that allows users to simulate the effects of real AC or DC power supply systems on DUT's in different test environments by importing real waveform data into the device, it supports up to 1024 points of data import.

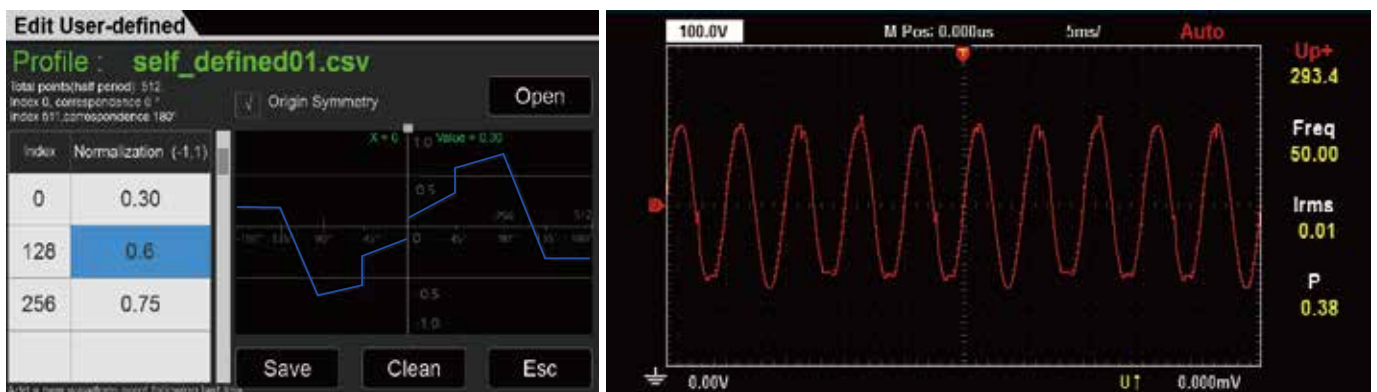

## Simulate power grid and low voltage ride through (LVRT) testing

Low voltage ride-through refers to the ability of the power generation system to continue to operate without disconnecting from the grid within a certain range of voltage drop when the grid fault or disturbance causes a voltage drop, and even provides a reactive power to help the system recover the voltage. You can edit the test parameters under LVRT condition. With the fast response, it can fully meet the test requirements of LVRT. At the same time, the IT7900EP series has the function of arbitrary waveform. With the LIST function, it can edit and simulate various grid disturbance waveforms through the panel or software, such as instantaneous power failure, surge and voltage rise and fall.

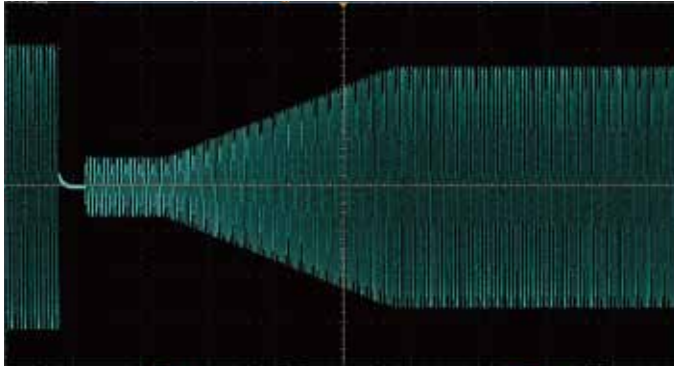

LVRT

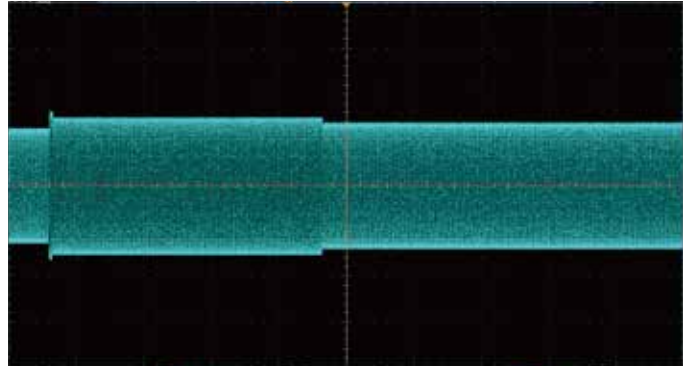

HVRT

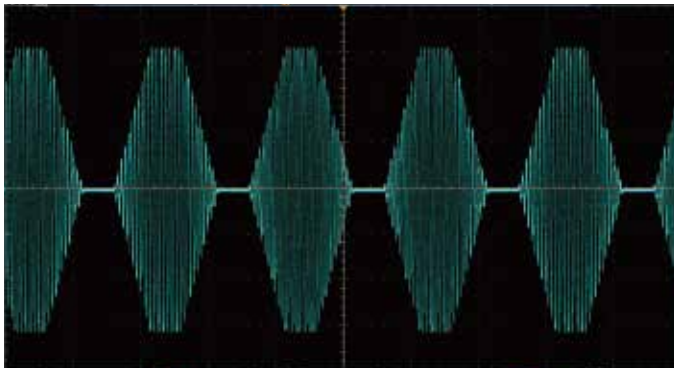

slow rise and fall

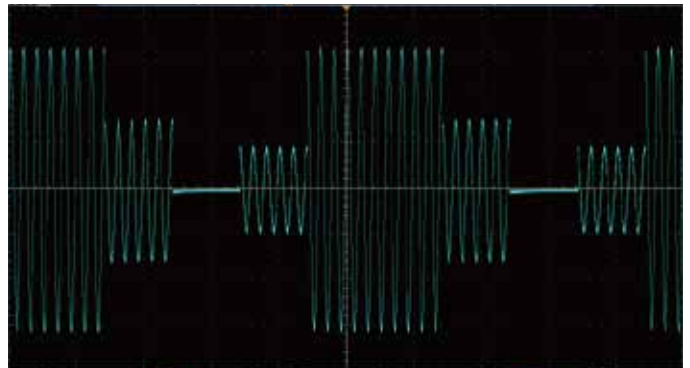

instantaneous power failure

## Harmonic and inter-harmonic simulation

With high-speed DSP technology, IT7900EP series is capable of simulating harmonic, inter-harmonic and harmonic synthesis. By setting the amplitude and phase, it can simulate up to 50th harmonics (fundamental frequency is 50Hz or 60Hz), creating a periodic distortion waveform. It also has built-in 30 types harmonic distortion waveforms for quick recall. Harmonic test is one of the important tests for EMC immunity, and single-phase harmonics, three-phase harmonics and three-phase harmonic unbalance output can be realized, also meet IEC regulations test requirements.

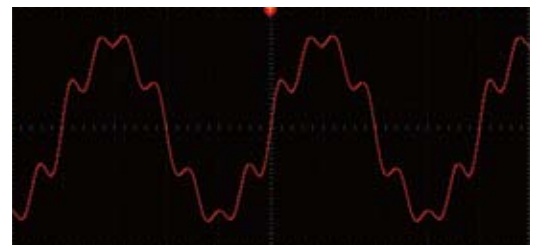
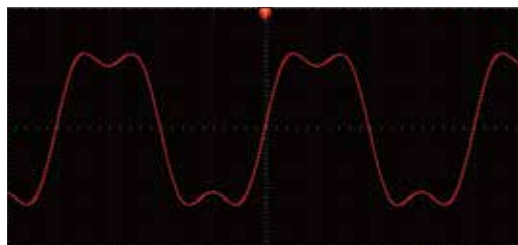
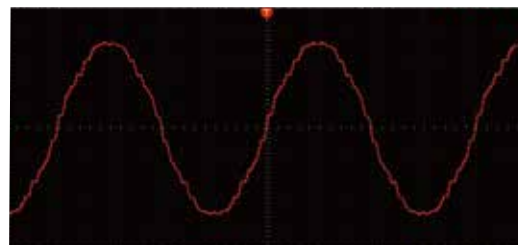
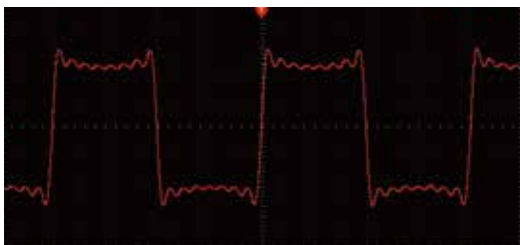

## LIST/SWEEP/Surge & Sag modes

IT7900EP series supports **NORMAL,LIST and SWEEP mode**. Each mode can work with **Surge&Sag function**.

- In LIST mode, a single file supports up to 200 steps, and the waveform type, voltage, frequency, slope and start-stop phase angle can be selected under each step. When the output voltage or frequency jumps, a trigger signal can be generated to synchronize external devices, which is especially suitable for large-scale test platforms with strict logic control and fast response for inter-device linkage.
- SWEEP is suitable for AC mode, which can test the efficiency of switching power supply, grab the voltage and frequency of the maximum power point, and change the setting parameters in a step-by-step way.

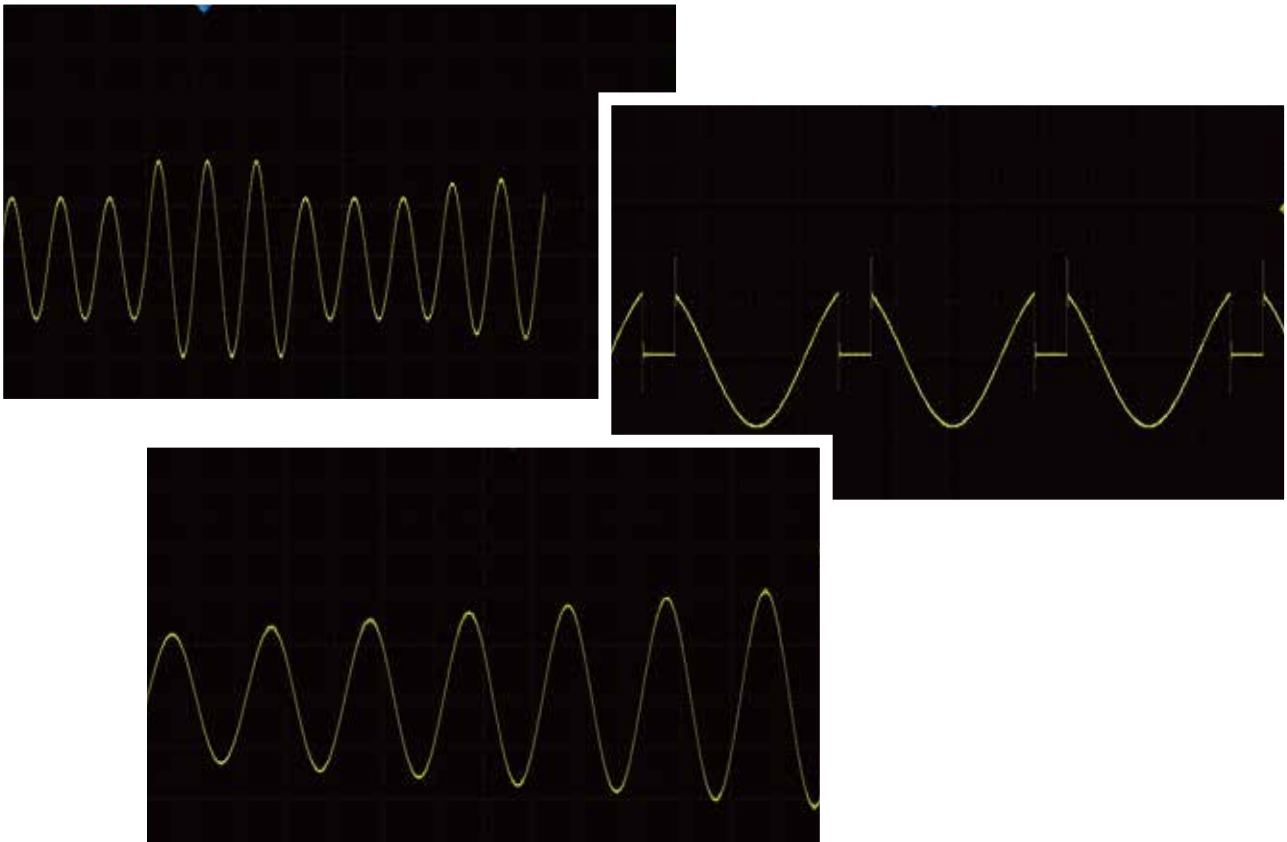

## Intuitive software interface

IT7900EP series provides free PC software PV7900P with an intuitive GUI. Meanwhile, it allows remote control, even the ATE models without display screen can be programmed, communicated and monitored.



## Optional Accessories

| Item              | Model          | Specification                               | Description               |                 |
|-------------------|----------------|---|---------------------------|-----------------|
| Parallel kit      | IT-E510-15U *1 | 15U unit, grey                              | 800mm X 550mm X907.64mm   |                 |
|                   | IT-E511-15U *1 | 15U unit, black                             | 800mm X 550mm X907.64mm   |                 |
|                   | IT-E510-27U *1 | 27U unit, grey                              | 800mm X 600mmX 1441.41mm  |                 |
|                   | IT-E511-27U *1 | 27U unit, black                             | 800mm X 600mmX 1441.41mm  |                 |
|                   | IT-E510-37U *1 | 37U unit, grey                              | 800mm X 600mm X 1885.91mm |                 |
|                   | IT-E511-37U *1 | 37U unit, black                             | 800mm X 600mm X 1885.91mm |                 |
|                   |                | IT-E168                                     | fiber kit for parallel    | for single unit |
|                   | IT-E169        | fiber kit for parallel                      | for cabinet               |                 |
| Other accessories | IT-E258        | power cord for 3U unit, 5m, US standard     | AC input power cord       |                 |
|                   | IT-E258-15U    | power cord for 15U cabinet, 5m, US standard | AC input power cord       |                 |
|                   | IT-E258-27U    | power cord for 27U cabinet, 5m, US standard | AC input power cord       |                 |
|                   | IT-E258-37U    | power cord for 37U cabinet, 5m, US standard | AC input power cord       |                 |
|                   |                | IT-E176                                     | GPIB                      |                 |
|                   |                | IT-E177                                     | RS232 & analog            |                 |

\*1 There is standard cabinet for models >30kVA



IT-E511-27U

| Input parameters (connect to grid)                   |  |   |   |
|--|--|---|---|
| AC Input   | wiring connection  | 3 phase 3wire + ground(PE)  |   |
|  | Line voltage   | RMS ( 200V ~ 220V ) ±10% *1 ( 380V ~ 480V ) ±10%  |   |
|  | Line current   | RMS < 47A   |   |
|  | Apparent Power   | < 24.4kVA   |   |
|  | Frequency  | 45 ~ 65Hz   |   |
|  | Power factor   | typ 0.98  |   |
| Output parameters (connect to EUT) (connect to grid) |  |   |   |
| AC Output  | Output voltage   | VLN *2  | 0 ~ 350V                                      |
|  |  | VLL   | 0 ~ 606V (3phase) / 0 ~ 700V (reverse)        |
|  | Output current   | RMS   | 105A (1phase) / 35A (3phase/reverse)          |
|  |  | Crest Factor *3   | 6   |
|  |  | Peak  | 315A (1phase) / 105A (3phase/reverse)         |
|  | Output power   | Per Phase/Per Channel   | 7kVA  |
|  |  | Max. Power  | 14kVA (reverse phase) / 21kVA (1phase/3phase) |
|  | Voltage setting  |   |   |
|  | Range  | 0 ~ 350V (1phase/3phase) / 0 ~ 700V (reverse)   |   |
|  | Resolution   | 0.01V   |   |
|  | Accuracy   | < 0.1%+0.1% F.S. (16Hz ~ 500Hz) / < 0.1%+(0.2%*kHz)F.S. (500.01Hz ~ 2.4kHz)   |   |
|  | DC offset voltage  | typ   | 0.02Vdc                                       |
|  | Current Limit setting  |   |   |
|  | Range  | RMS   | 105A (1phase) / 35A (3phase/reverse)          |
|  | Resolution   | 0.01A   |   |
|  | Accuracy   | < 0.1% + 0.2% F.S. (16Hz ~ 150Hz) / < 0.2% + 0.3% F.S. (150.01Hz ~ 500Hz) / < 0.3%+(0.6%*kHz) F.S (500.01Hz ~ 2.4kHz) |   |
|  | Frequency  |   |   |
|  | Range  | 16 ~ 500Hz (Low *4) / 16 ~ 2.4k (High *4)   |   |
|  | Resolution   | 0.01Hz  |   |
|  | Accuracy   | 0.01% (16Hz ~ 500Hz) / 0.1% (500.01Hz ~ 2.4kHz)   |   |
|  | waveform synthesis   | 50/60Hz   | up to 50 orders                               |
|  | Phase  |   |   |
|  | Range  | 0 ~ 360°  |   |
|  | Resolution   | 0.01°   |   |
| voltage setting                                      |  |   |   |
| Range  | -499 ~ 499Vdc (1phase) / -998 ~ 998Vdc (reverse)                               |   |   |
| Resolution   | 0.01V  |   |   |
| Accuracy   | < 0.1%+0.1% F.S  |   |   |
| Current setting                                      |  |   |   |
| Range  | -35 ~ 35Adc (reverse) / -105 ~ 105Adc (1phase)                                 |   |   |
| Resolution   | 0.01A  |   |   |
| Accuracy   | < 0.1% + 0.2% F.S.   |   |   |
| Max. power   |  |   |   |
| Phase power  | Per Channel  | 7kW   |   |
| Max.power (reversephase)                             | Max. Power (reverse phase)   | 14kW  |   |
| Total power  | Max. Power (1phase)  | 21kW  |   |
| Voltage stability                                    | Line regulation  | < 0.05% F.S.  |   |
|  | Load regulation*5  | < 0.05% + 0.05% F.S.(DC,16Hz ~ 500Hz) / < 0.05% + (0.1%*kHz) F.S(500.01Hz ~ 2.4kHz)                                   |   |
|  | THD *6   | < 0.5%(16Hz ~ 100Hz) / < 1%(100.01Hz ~ 500Hz) / < 1%+(1%*kHz) F.S.(500.01Hz ~ 2.4kHz)                                 |   |
|  | Voltage ripple   | RMS   | < 0.4V  |
|  | Dynamic response*7   | typ   | 200us   |
| Programmable impedance                               | R Range  | 0 ~ 1000mΩ(3phase) / 0 ~ 333.333mΩ(1phase) / 0 ~ 2000mΩ(reverse)  |   |
|  | L Range  | 0 ~ 1000uH (3phase) / 0 ~ 333.333uH (1phase) / 0 ~ 2000uH (reverse)   |   |
| RLC  | P Range  | 0 ~ 7kW (3phase) / 0 ~ 21kW (1phase) / 0 ~ 14kW (reverse)   |   |
|  | QL Range   | 0 ~ 7kVar (3phase) / 0 ~ 21kVar (1phase) / 0 ~ 14kVar (reverse)   |   |
|  | QC Range   | 0 ~ 7kVar (3phase) / 0 ~ 21kVar (1phase) / 0 ~ 14kVar (reverse)   |   |
|  | R Range  | 1 ~ 1000Ω (3phase) / 0.333 ~ 333.333Ω (1phase) / 2 ~ 2000Ω (reverse)  |   |
|  | L Range  | 1 ~ 5000mH (3phase) / 0.333 ~ 1666.667mH (1phase) / 2 ~ 10000mH (reverse)   |   |
|  | C Range  | 0.001 ~ 5mF (3phase) / 0.003 ~ 15mF (1phase) / 0.001 ~ 2.5mF (reverse)  |   |
|  | Voltage Slew Rate, Typical   | ≥ 2 V/μs with full-scale programmed voltage step  |   |
| Output Isolation                                     | 550Vac   |   |   |
| Output parameters (electronic load mode)             |  |   |   |
| AC Mode  | Input voltage  | VLN   | 30 ~ 350V                                     |
|  |  | VLL   | 51.96 ~ 606V (3phase) 30 ~ 700V (reverse)     |
|  | Input frequency  | 16~500Hz  |   |
|  | Input current  | RMS   | 105A (1phase) / 35A (3phase/reverse)          |
|  |  | Crest Factor *8   | 5   |
|  |  | Peak  | 315A (1phase) / 105A (3phase/reverse)         |
|  | Input power  | Per Phase   | 7kVA (3phase)                                 |
|  |  | Max. Power  | 14kVA (reverse phase) / 21kVA (1phase/3phase) |
|  | CC Mode  |   |   |
|  | Current range  | RMS   | 105A (1phase) / 35A (3phase/reverse)          |
| Resolution   | 0.01A  |   |   |
| Accuracy*9   | < 0.1% + 0.2% F.S. (DC,16Hz ~ 150Hz) / < 0.2% + 0.3% F.S.(150.1Hz ~ 500Hz *10) |   |   |
| CP Mode  |  |   |   |
| Range  | Max. Power   | 21kW (1phase/3phase) / 14kW (reverse phase)   |   |
|  | Per Phase  | 7kW (3phase)  |   |
| Resolution   | 0.001kW  |   |   |
| Accuracy   | < 0.4% + 0.4% F.S. (DC,16Hz ~ 500Hz)   |   |   |

|  |  |   |   |   |
|--|--|---|---|---|
| AC Mode                                      | CS Mode  |   |   |   |
|  | Range  | Max. Power  | 21kVA (1phase/3phase) / 14kVA (reverse phase)                                       |   |
|  |  | Per Phase   | 7kVA (3phase)   |   |
|  |  | Resolution  | 0.001kVA  |   |
|  |  | Accuracy  | <0.4% +0.4% F.S. (16Hz ~ 500Hz)   |   |
|  | CR Mode  |   |   |   |
|  |  | Range   | 0.334 ~ 388.88Ω(1phase) / 1.002 ~ 1166.6Ω (reverse phase) / 1.002 ~ 1166.6(3phase)  |   |
|  |  | Resolution  | 0.001Ω  |   |
|  |  | Accuracy*11   | 0.4%+0.4%F.S.   |   |
|  | Parallel rlc: Circuit Emulation(CE)-Parallel rlc                             |   |   |   |
|  |  | R Range   | 0.334 ~ 388.88Ω(1phase) / 1.002 ~ 1166.6(reverse phase) / 1.002 ~ 1166.6(3phase)    |   |
|  |  | L Range   | 1 ~ 2000mH (1phase) / 3 ~ 2000mH (reverse phase) / 3 ~ 2000mH(3phase)               |   |
|  |  | C Range   | 0.001 ~ 9900uF (1phase) / 0.001 ~ 3300uF (reverse phase) / 0.001 ~ 3300uF (3phase)  |   |
|  |  | Rc Range  | 0.334 ~ 388.88Ω(1phase) / 1.002 ~ 1166.6Ω (reverse phase) / 1.002 ~ 1166.6 (3phase) |   |
|  |  | RL Range  | 0.334 ~ 388.88Ω(1phase) / 1.002 ~ 1166.6Ω(reverse phase) / 1.002 ~ 1166.6(3phase)   |   |
|  |  | IL Range  | 0 ~ 318.15A (1phase) / 0 ~ 106.05A (reverse phase) / 0 ~ 106.05A (3phase)           |   |
|  |  | Max peak current  | 318.15A (1phase) / 106.05A (reverse phase) / 106.05A (3phase)                       |   |
|  | Rectifier single phase rlc: Circuit Emulation(CE)-Rectifier single phase rlc |   |   |   |
|  |  | R Range   | 0.334 ~ 388.88Ω(1phase) / 1.002 ~ 1166.6(reverse phase) / 1.002 ~ 1166.6(3phase)    |   |
|  |  | L Range   | 0.1 ~ 2000mH(1phase) / 0.3 ~ 2000mH (reverse phase) / 0.3 ~ 2000mH (3phase)         |   |
|  |  | C Range   | 0.001 ~ 9900uF (1phase) / 0.001 ~ 3300uF (reverse phase) / 0.001 ~ 3300uF (3phase)  |   |
|  |  | RS Range  | 0 ~ 388.88Ω(1phase) / 0 ~ 1166.6Ω (reverse phase) / 0 ~ 1166.6Ω(3phase)             |   |
|  |  | Vcap Range  | 0 ~ 499.924V (1phase) / 0 ~ 499.924V (reverse phase) / 0 ~ 499.924V (3phase)        |   |
|  |  | Vdiode Range  | 0 ~ 5V (1phase) / 0 ~ 5V (reverse phase) / 0 ~ 5V (3phase)                          |   |
|  |  | Max peak current  | 318.15A (1phase) / 106.05A (reverse phase) / 106.05A (3phase)                       |   |
|  | Phase Range  |   |   |   |
|  |  | Range   | Rectified Mode *12  | -82.8°~+82.8°   |
|  |  |   |   | -180° ~ +180°(Current Source Mode: +90.01° ~ +180° & -90.01° ~ -180°) |
|  |  | Resolution  | 0.01°   |   |
|  |  | Accuracy*13   | 1% F.S.   |   |
|  | CF setting   |   |   |   |
|  |  | Range   | 1.414 ~ 5.0   |   |
|  |  | Resolution  | 0.001   |   |
| PF setting                                   |  |   |   |   |
|  | Range  | 0 ~ 1.00  |   |   |
|  | Resolution   | 0.01  |   |   |
| DC Mode                                      | voltage range  | 30 ~ 499 (1phase) / 30 ~ 998 (reverse phase)  |   |   |
|  | current range  | 0 ~ 105A (1phase) / 0 ~ 35 (reverse phase)  |   |   |
|  | current rise time  | 200us   |   |   |
|  | working mode   | CC, CV, CR, CP, CC+CV, CR+CV, CP+CV, CC+CR, CC+CV+CP+CR   |   |   |
|  |  |   |   |   |
| Measurement parameter (grid simulator mode)  |  |   |   |   |
| Voltage RMS                                  | Resolution   | 0.01V   |   |   |
|  | Accuracy   | <0.1%+0.1% F.S. (DC,16Hz~500Hz) / <0.1%+(0.2%*kHz) F.S (500.01Hz~2.4kHz)  |   |   |
| Current RMS                                  | Resolution   | 0.1A  |   |   |
|  | Accuracy   | <0.1% + 0.2% F.S. (DC,16Hz ~ 150Hz) / <0.2% + 0.3% F.S. (150.01Hz~500Hz) / <0.3% + (0.6%*kHz) F.S (500.01Hz~2.4kHz) |   |   |
| Peak current                                 | Resolution   | 0.1A  |   |   |
|  | Accuracy   | <0.4% + 0.6% F.S. (16Hz~500Hz) / <0.4% + (1.2%*kHz) F.S (500.01Hz~2.4kHz)   |   |   |
| Output power                                 | Resolution   | 0.001kW   |   |   |
|  | Accuracy   | <0.4%+0.4% F.S. (DC,16Hz~500Hz) / <0.4% +<(0.8%*kHz) F.S (500.01Hz~2.4kHz)  |   |   |
| Harmonic measurement                         | Max.   | 50/60Hz   | up to 50 orders   |   |
| Measurement parameter (electronic load mode) |  |   |   |   |
| Voltage RMS                                  | Range  | 0 ~ 350Vrms   |   |   |
|  | Resolution   | 0.01V   |   |   |
|  | Accuracy   | <0.1%+0.1% F.S. (DC,16Hz~500Hz)   |   |   |
| Current RMS                                  | Range  | 0 ~ 105A  |   |   |
|  | Resolution   | 0.1A  |   |   |
|  | Accuracy   | <0.1% + 0.2% F.S. (DC,16Hz ~ 150Hz) / <0.2% + 0.3% F.S. (150.1Hz ~ 500Hz)   |   |   |
| Peak current                                 | Range  | 0 ~ 315A  |   |   |
|  | Resolution   | 0.1A  |   |   |
|  | Accuracy   | <0.3% + 0.6% F.S. (16Hz~500Hz)  |   |   |
| Active power                                 | Range  | 0 ~ 21kW  |   |   |
|  | Resolution   | 0.001kW   |   |   |
|  | Accuracy   | <0.4% +0.4% F.S.  |   |   |
| Reactive power                               | Range  | 0 ~ 21kVAR  |   |   |
|  | Resolution   | 0.001kVAR   |   |   |
|  | Accuracy   | <0.4% +0.4% F.S.  |   |   |
| Apparent power                               | Range  | 0 ~ 21KVA   |   |   |
|  | Resolution   | 0.001KVA  |   |   |
|  | Accuracy   | <0.4% +0.4% F.S.  |   |   |
| CF measurement                               | Range  | 1 ~ 5   |   |   |
|  | Resolution   | 0.01  |   |   |
| PF measurement                               | Range  | 0.1 ~ 1   |   |   |
|  | Accuracy   | 1%F.S.  |   |   |

## IT7900EP High Performance Regenerative Grid Simulator

|                                   |        |   |                 |
|-----------------------------------|--------|---|-----------------|
| Harmonic measurement              | Max.   | 50/60Hz   | up to 50 orders |
| <b>Regenerative</b>               |        |   |                 |
| Max. Regenerative power           |        | 21kVA   |                 |
| THD                               |        | < 5%  |                 |
| <b>Others</b>                     |        |   |                 |
| Efficiency                        | typ*14 | 91%   |                 |
| Protection                        |        | OVP, OCP, OPP, OTP, FAN, ECP, Sense, UVP(load), FE(load)  |                 |
| dimension                         |        | 483.00mm(W)*151.30mm(H)*777.50mm(D)(841.6mm cover and holder included)                                      |                 |
| Weight                            |        | 42kg  |                 |
| Working temperature               |        | 0 C -50 C   |                 |
| Programming response time         |        | 2ms   |                 |
| Remote Sense Compensation Voltage |        | 20V   |                 |
| Communication interface           |        | Built in USB/CAN/LAN/digital IO communication interface, optional GPIB/analog&RS232 communication interface |                 |

\*1 (200 ~ 220) ±10%, power is 60% of the rated.

\*2 Depending on the frequency, the output voltage will decrease. The rated voltage can be output below 1.4kHz, the maximum output voltage at 2kHz is 250.76Vrms, and the maximum output voltage at 2.4kHz is 208.97Vrms.

\*3 When the output frequency is below 50Hz/60Hz, and the peak current is not exceeded, the maximum CF is 6; under the condition of full current and full power, the maximum CF is 3.

\*4 When LoopSpeed is low, it can better complied DUT's characteristics; When LoopSpeed is High, the dynamic response time will be faster.

\*5 Parallel models need to use sense remote measurement mode for testing.

\*6 Test condition: pure resistive load, under full power condition.

\*7 Dynamic response time test condition, DC mode, high speed, capacitance of DUT < 10uF.

\*8 When the input frequency is below 50Hz/60Hz, and the peak current is not exceeded, the maximum CF is 5; under the condition of full current and full power, the maximum CF is 3.

\*9 For frequency < 150Hz, the minimum current for accuracy test is 1%F.S., for frequency > 150Hz, the minimum current for accuracy test is 3%F.S.

\*10 When LoopSpeed is Low, it is more adaptable to the load; when LoopSpeed is Fast, the dynamic response is faster; when the frequency is high, please use Fast mode.

\*11 Under condition:  $I > 10\%F.S.$ ,  $F < 150Hz$

\*12 In the rectifier load mode, the setting range of the phase angle is related to CF. The larger the CF, the larger the set range of the phase angle.

\*13  $\leq 150Hz$ , 1%F.S.,  $> 150Hz$ , 5%F.S.

\*14 Test conditions: Input 380VLL/50Hz, output three-phase, each phase 350Vrms/50Hz/7kW.

\*All the above parameters are subject to change without prior notice from ITECH.

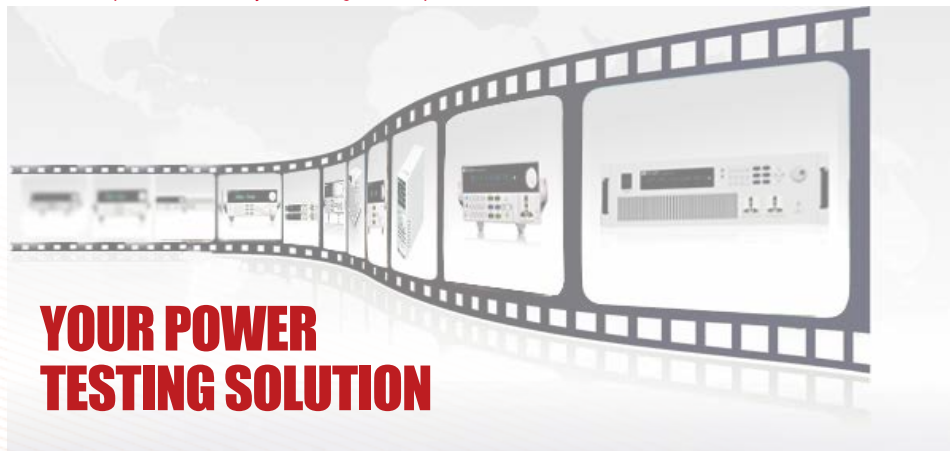

This information is subject to change without notice. For more information, please contact ITECH.

## Taipei

Add: No.918, Zhongzheng Rd., Zhonghe Dist., New Taipei City  
235, Taiwan

Web: [www.itechate.com](http://www.itechate.com)

TEL: +886-3-6684333

E-mail: [info@itechate.com](mailto:info@itechate.com)



ITECH Web



ITECH Facebook



ITECH LinkedIn